

# 2

1.

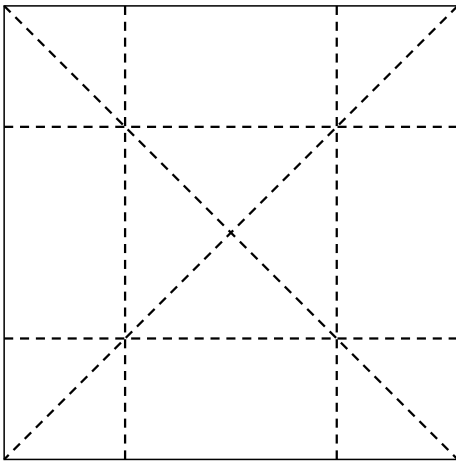

Crease the 4/15 Base.

2.

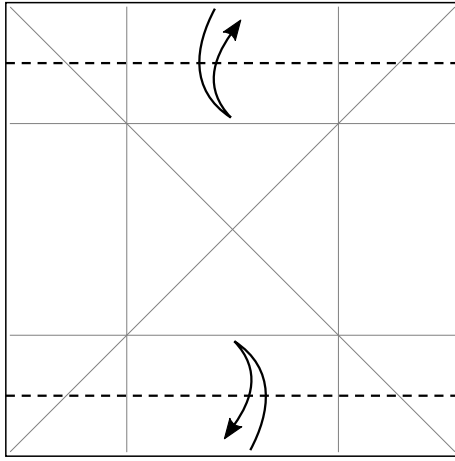

Fold the edges to the creases and unfold.

3.

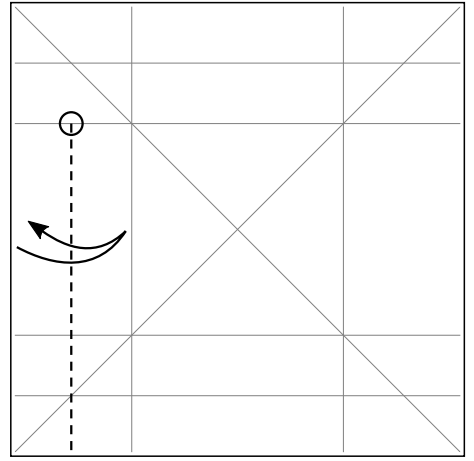

Bring the edge to the crease and crease up to the circled point.

4.

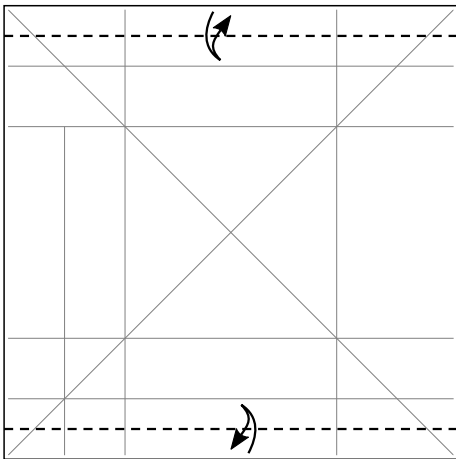

Fold the edges to the creases and unfold.

5.

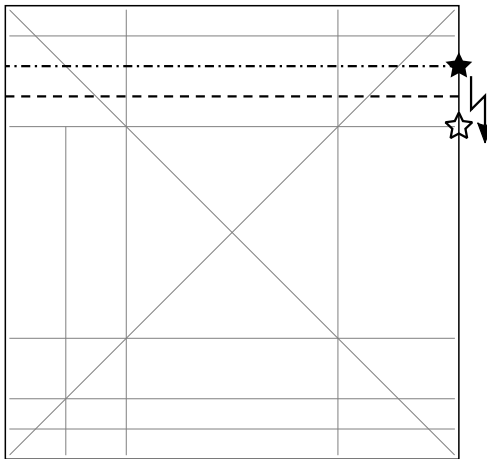

Pleat and unfold.

6.

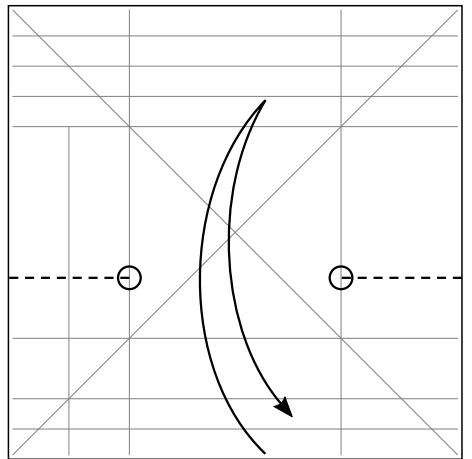

Bring the edge to the crease and crease up to the circled points.

7.

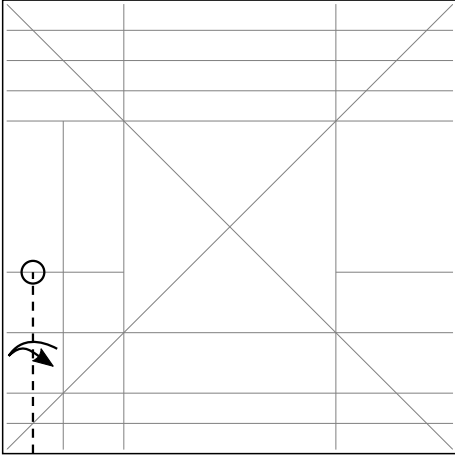

Bring the edge to the crease and crease up to the circled point.

8.

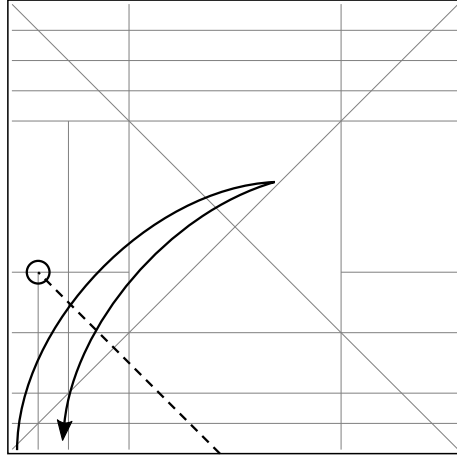

Bring the corner to the diagonal and crease up to the circled point.

9.

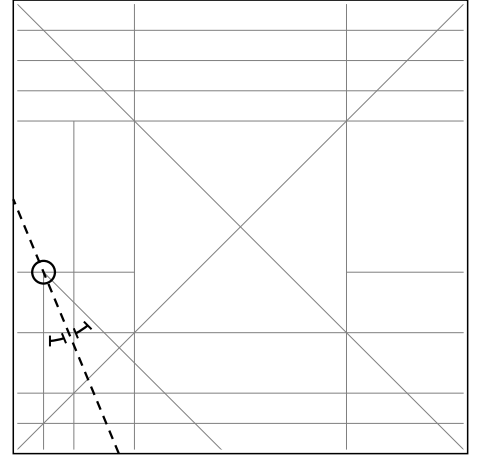

Crease the angle bisector.

10.

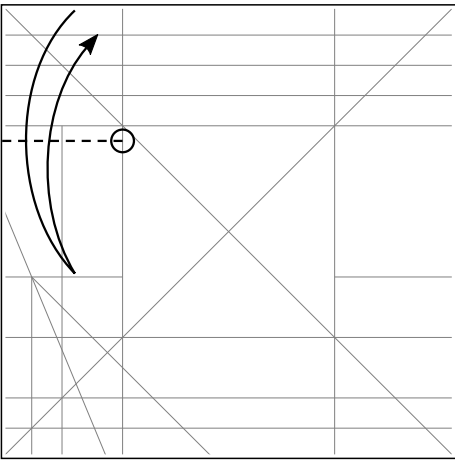

Bring the edge to the crease and crease up to the circled point.

11.

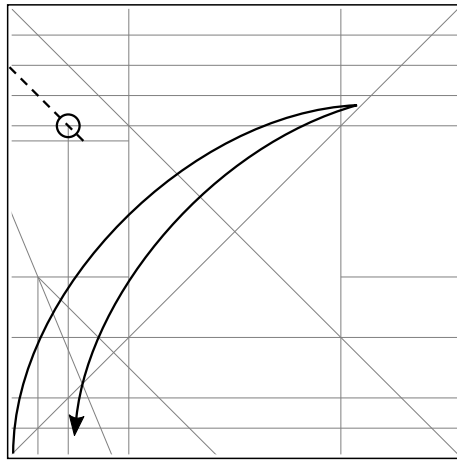

Bring the corner to the diagonal and crease slightly past the circled point.

12.

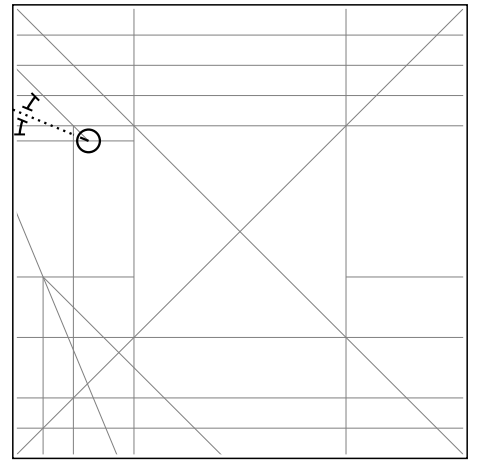

Make a tiny crease along the angle bisector.

13.

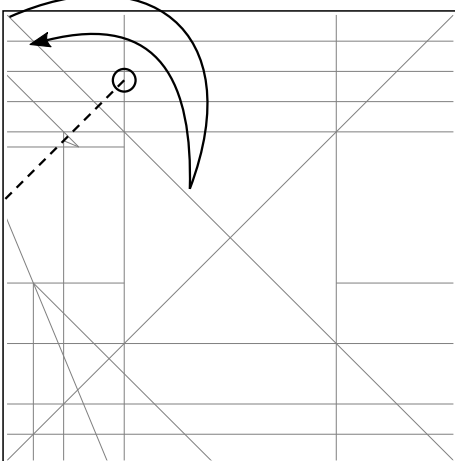

Crease up to the circled point, through the crease made in Step 12.

14.

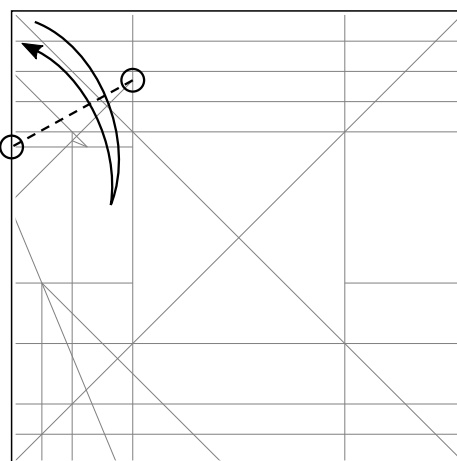

Crease up to the circled point, through the crease made in Step 12.

15.

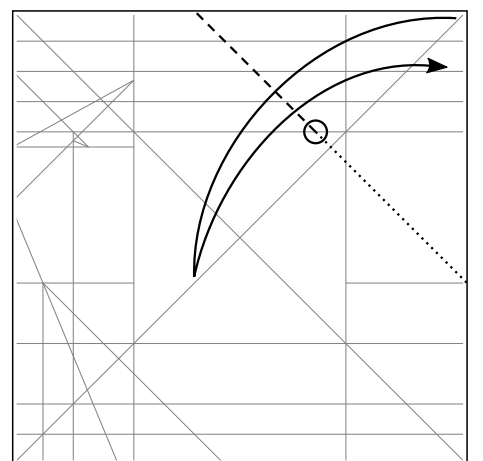

Bring the corner to the diagonal and crease up to the circled point.

16.

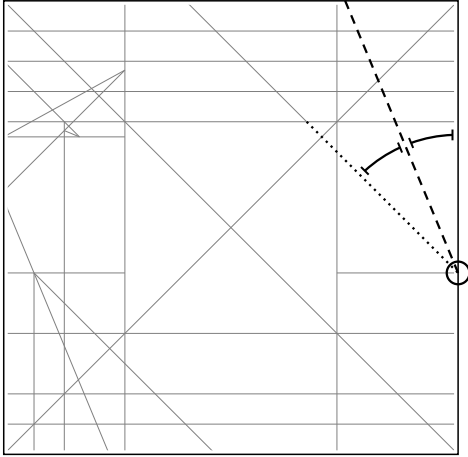

Crease the angle bisector.

17.

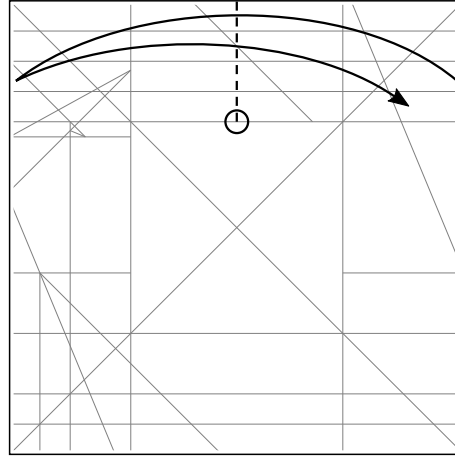

Bring the edge to the edge and crease up to the circled point.

18.

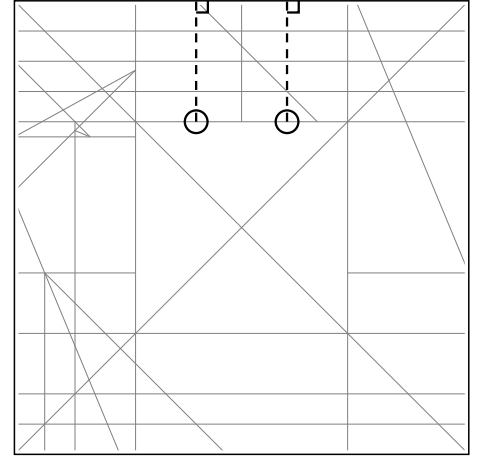

Make two creases up to the circled points at the crease made in Step 15.

19.

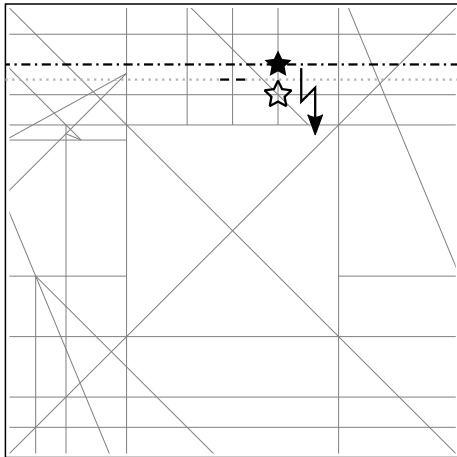

Partially pleat and pinch at the crease made in Step 17.

20.

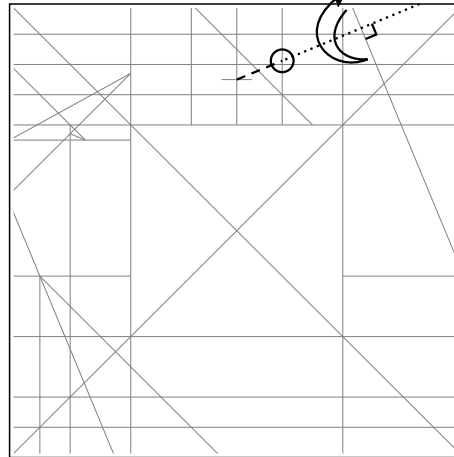

Crease up to the circled point.

21.

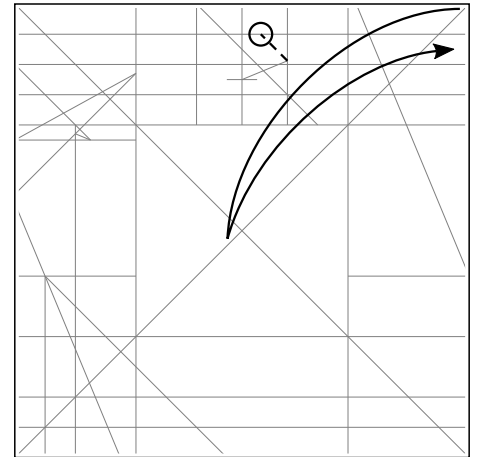

Crease from the crease made in Step 20 to the circled point.

22.

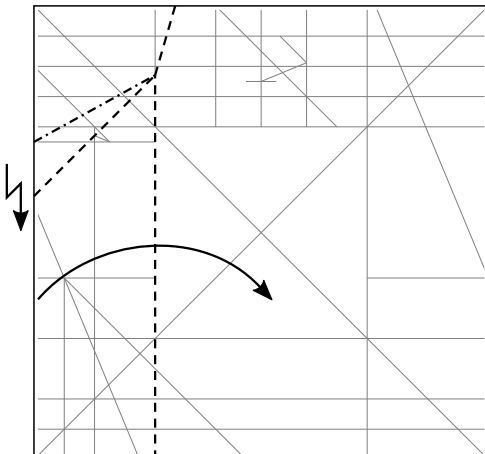

Collapse along three existing creases and one new crease.

23.

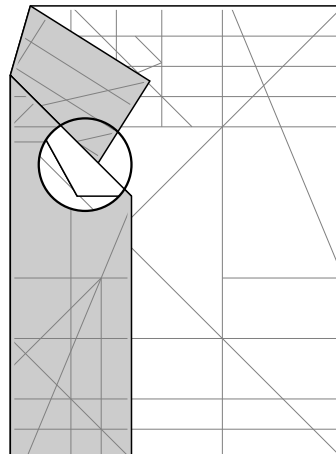

X-ray view.

24.

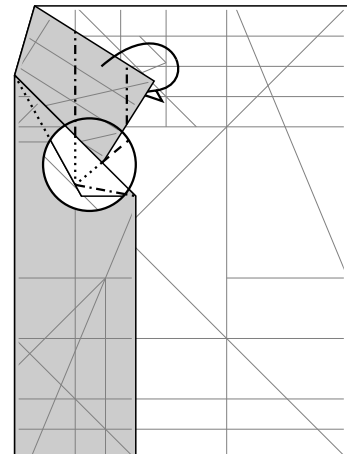

Swivel-fold inward, lining up the fold with the crease behind. The tip will bend a little. Fold it away.

25.

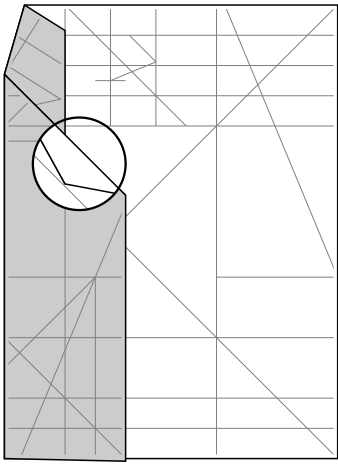

Like this.  
Return to normal view.

26.

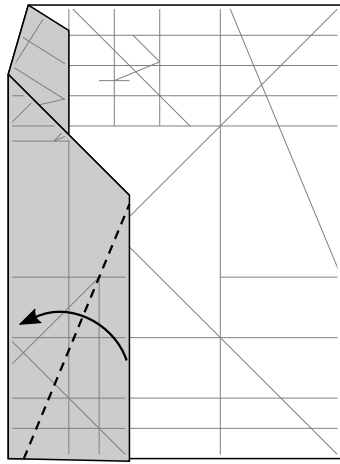

27.

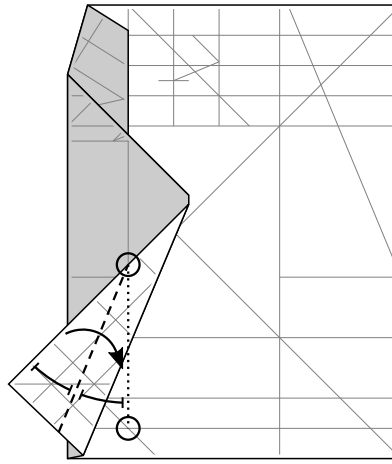

Fold the angle bisector.

28.

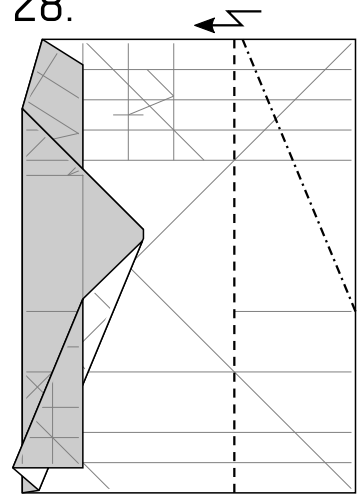

Crimp.

29.

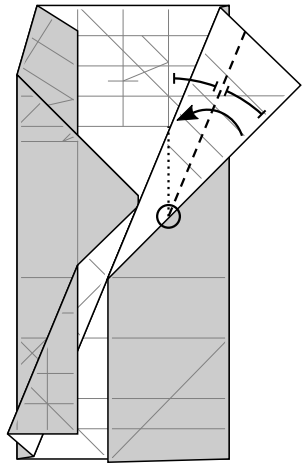

Fold the angle bisector.

30.

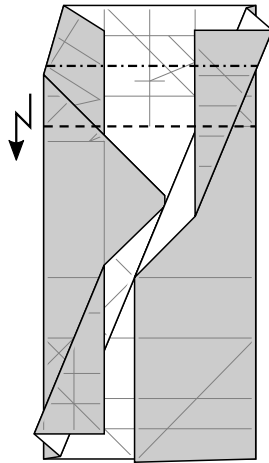

Pleat.

31.

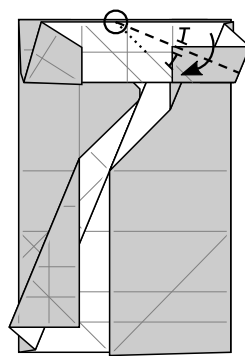

Fold the  
angle bisector.

32.

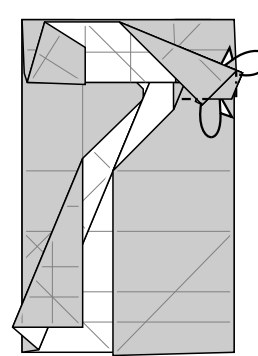

Fold the corners  
inward.

33.

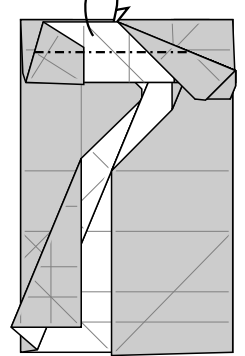

Fold the edge  
inward.

34.

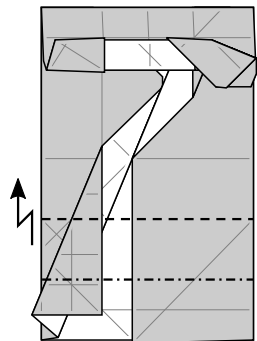

Pleat.

35.

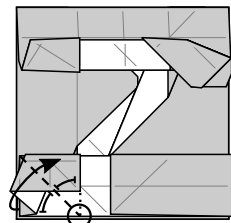

Fold the  
angle bisector.

36.

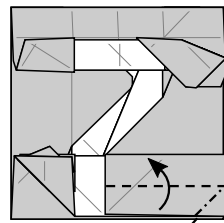

Swivel-fold.

37.

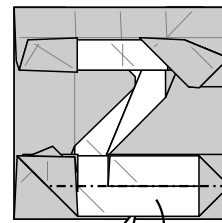

Fold the edge  
inward.

38.

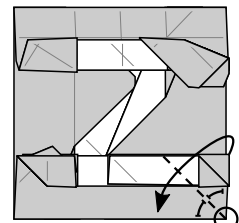

Fold the  
angle bisector.

39.

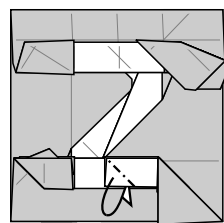

Fold inward to hide the wrong-color seam.

40.

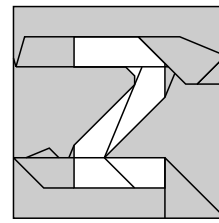

Finished!