

1

The simplest of the numbers. All creases are 45°-aligned.

1.

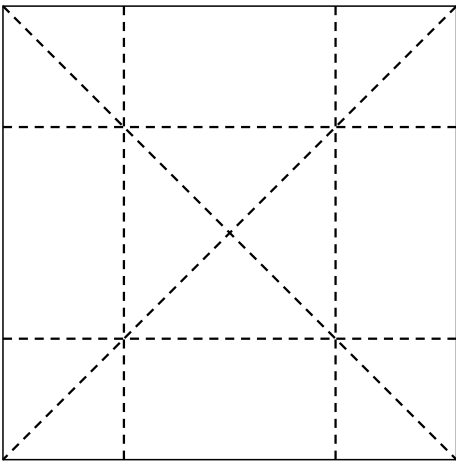

Crease the 4/15 Base.

2.

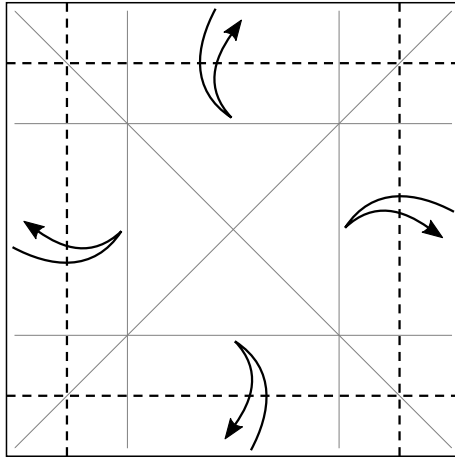

Fold the edges to the creases and unfold.

3.

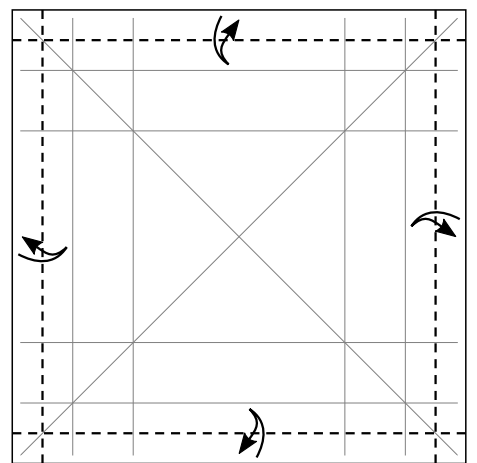

Fold the edges to the creases and unfold.

4.

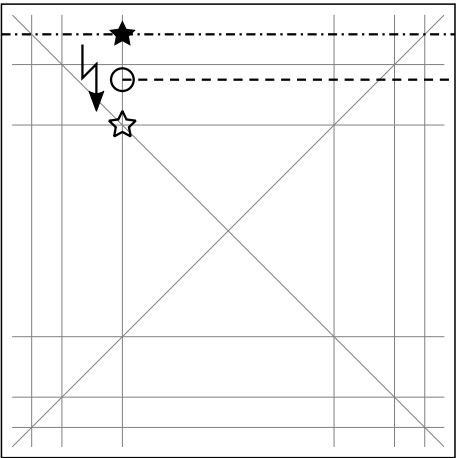

Partially pleat and unfold.

5.

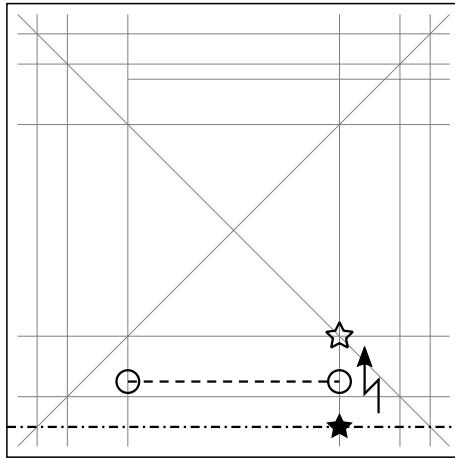

Partially pleat and unfold.

6.

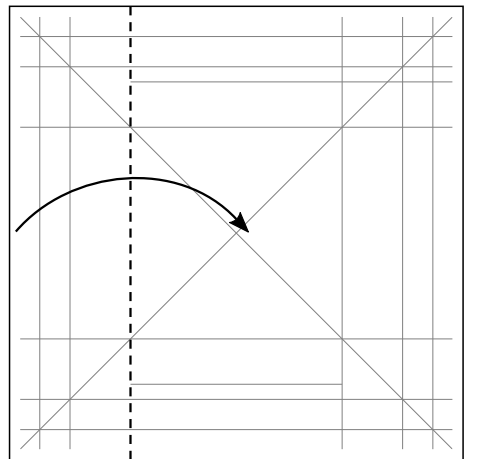

7.

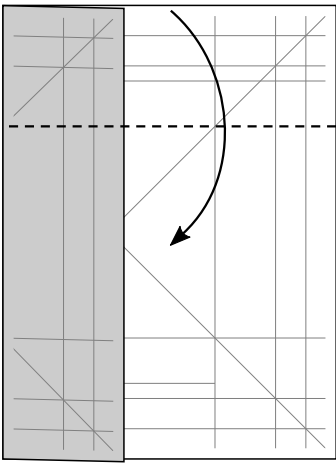

8.

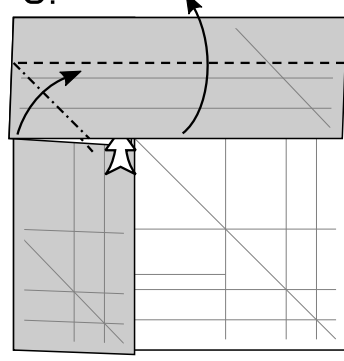

Swivel-fold.

9.

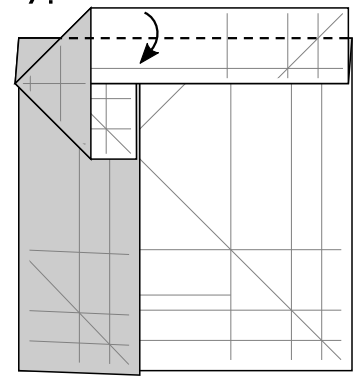

10.

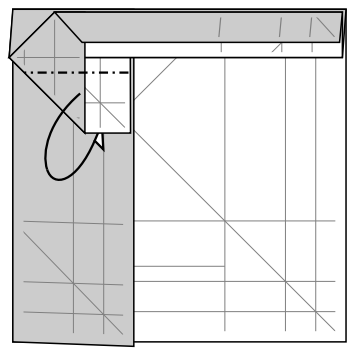

Fold the flap inward along the crease.

11.

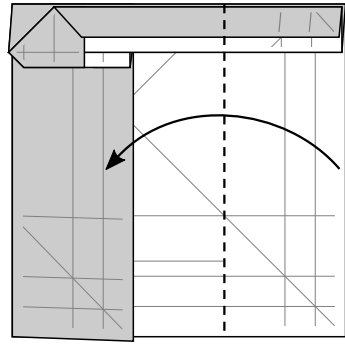

12.

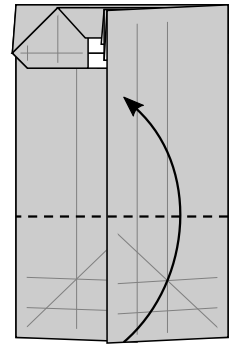

13.

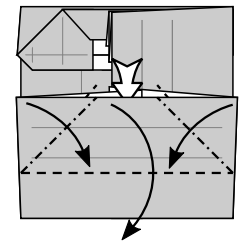

Swivel-fold.

14.

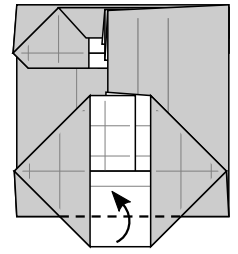

15.

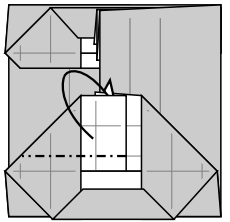

Fold the flap inward along the crease.

16.

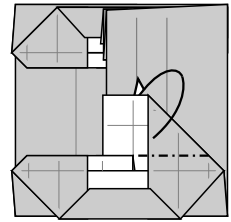

Fold the flap inward along the crease.

17.

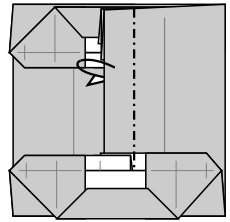

Fold the edge inward along the crease. You may need to open the model a bit.

18.

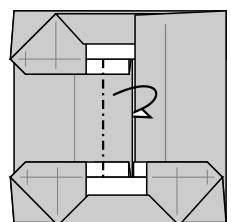

Fold the edge inward along the crease. You may need to open the model a bit.

19.

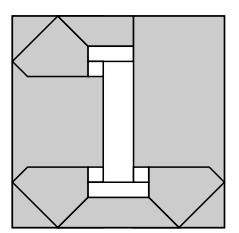

Finished!